



CINDI IN SPACE

HI THERE!  
MY NAME IS CINDI AND  
I'M AN ANDROID GIRL! I LIVE  
OUT HERE IN A SPACE STATION  
IN ORBIT AROUND THE EARTH.  
MY JOB IS TO CATCH  
DOGS...

THAT'S  
RIGHT.  
DOGS...

YOU MEAN  
YOU'VE NEVER  
HEARD OF  
SPACE DOGS  
BEFORE?

YEAH, PEOPLE  
HAVE THIS IDEA THAT  
DOGS ONLY EXIST DOWN  
THERE ON THE  
GROUND.

BUT WE  
HAVE A FEW OF  
THEM UP HERE  
IN SPACE  
TOO.

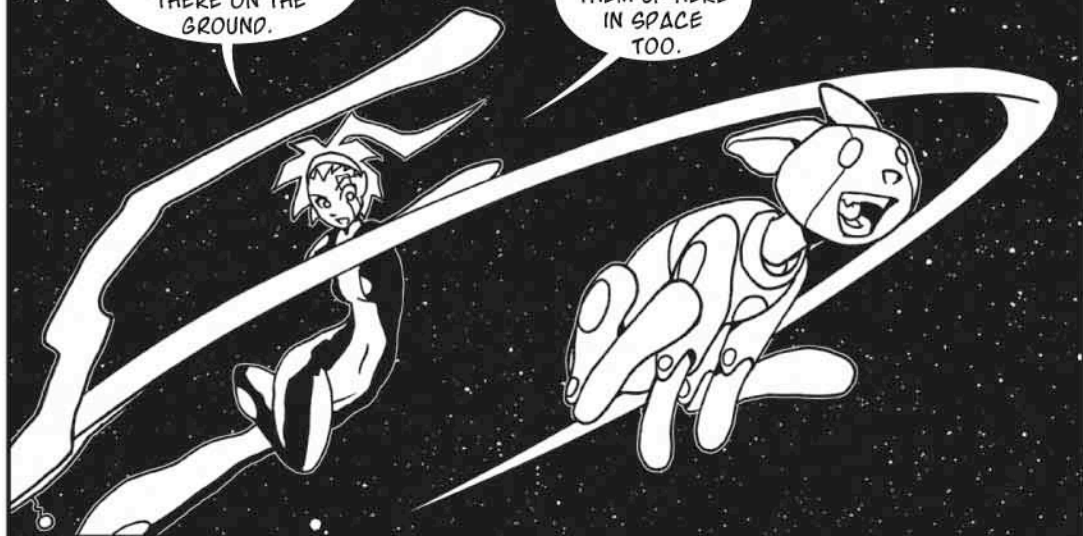

OF COURSE  
THEY'RE ALL ANDROID  
DOGS. HERE ARE MY TWO  
DOGS: TEKS AND TAKS.  
THEY LIVE UP HERE  
WITH ME.

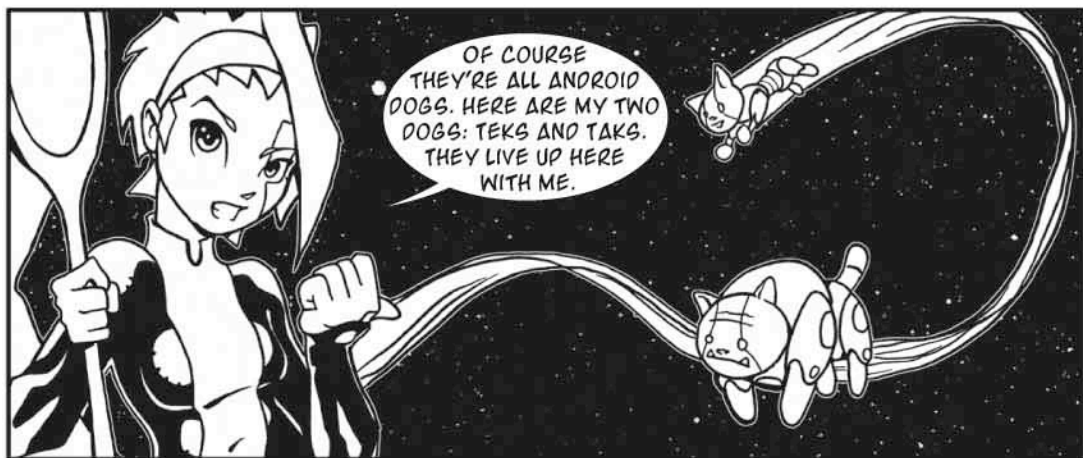

OH, YOU NOTICED THE  
DIFFERENCE BETWEEN  
THEM HUH?

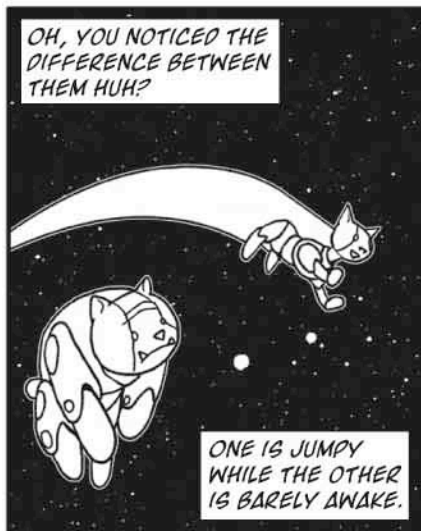

ONE IS JUMPY  
WHILE THE OTHER  
IS BARELY AWAKE.



THIS IS TAKS. HE'S  
JUMPY BECAUSE HE'S  
MISSING HIS TAIL, SO  
HE'S POSITIVELY  
CHARGED UP!

AND THIS IS TEKS. HE  
STILL HAS HIS TAIL SO  
HE'S NOT CHARGED UP  
AT ALL.



YOU SEE, THAT'S THE WAY ANDROID DOGS BEHAVE. THEY ARE ELECTRICAL AFTER ALL. THEIR BODIES HAVE POSITIVE CHARGE AND THEIR TAILS HAVE NEGATIVE CHARGE.

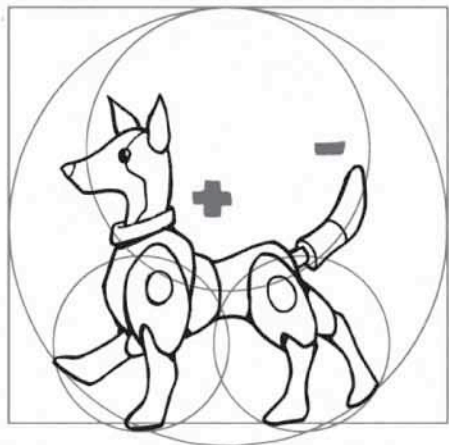

SO TEKS IS LIKE THIS SINCE HIS POSITIVE AND NEGATIVE CHARGED PARTS CANCEL OUT.



BUT HE'S LIKE THIS UNTIL HE EATS ONE OF THESE ENERGY BISCUITS.



CHOMP  
CHOMP



IF THERE IS ENOUGH ENERGY IN THE BISCUIT, HIS TAIL FLIES OFF AND HE BECOMES ENERGIZED.



FORTUNATELY, THEY DON'T STAY LIKE THIS ALL THE TIME.



THERE ARE LOTS OF LOOSE TAILS FLYING AROUND UP HERE THAT HAVE POPPED OFF OF OTHER SPACE DOGS, SO....

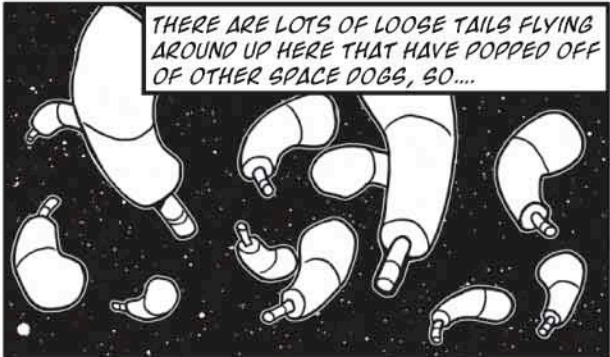

...SOMETIMES THE ELECTRICAL ATTRACTION BETWEEN THEM CAUSES ONE OF THE LOOSE TAILS TO ATTACH ITSELF BACK ON THE DOG.

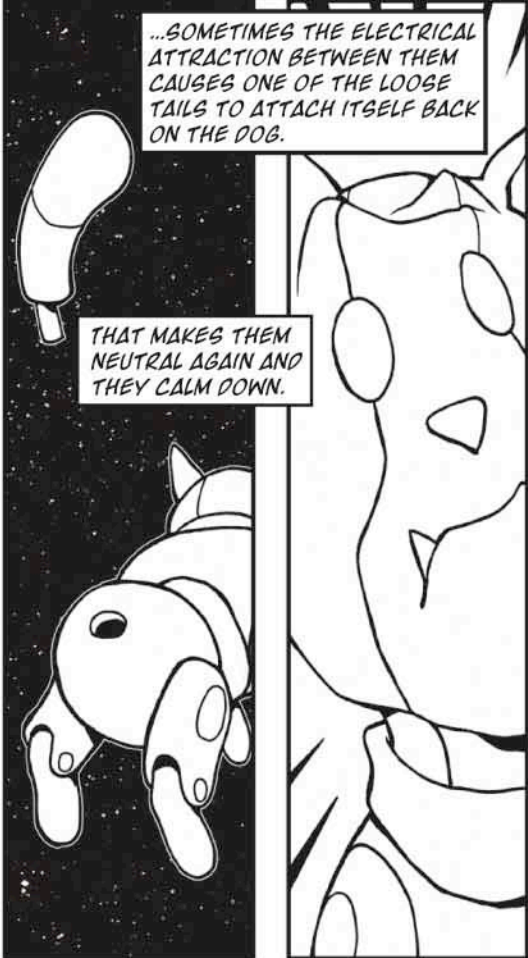

THAT MAKES THEM NEUTRAL AGAIN AND THEY CALM DOWN.

OH YEAH, WHEN THE TAIL REATTACHES THEY HAVE TO GET RID OF THE EXTRA ENERGY...

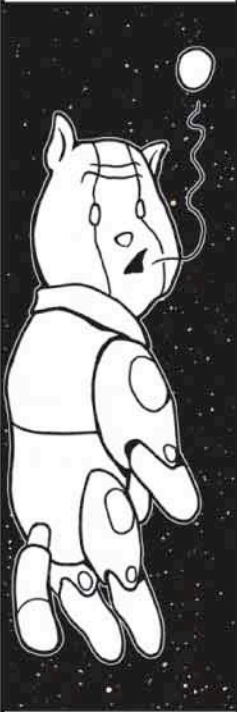

...SO SOMETIMES THEY SPIT OUT ANOTHER ENERGY BISCUIT.

IF THIS WAS A REAL DOG, THIS WOULD BE **GROSS!** FORTUNATELY THEY'RE ANDROIDS, SO IT'S NOT.



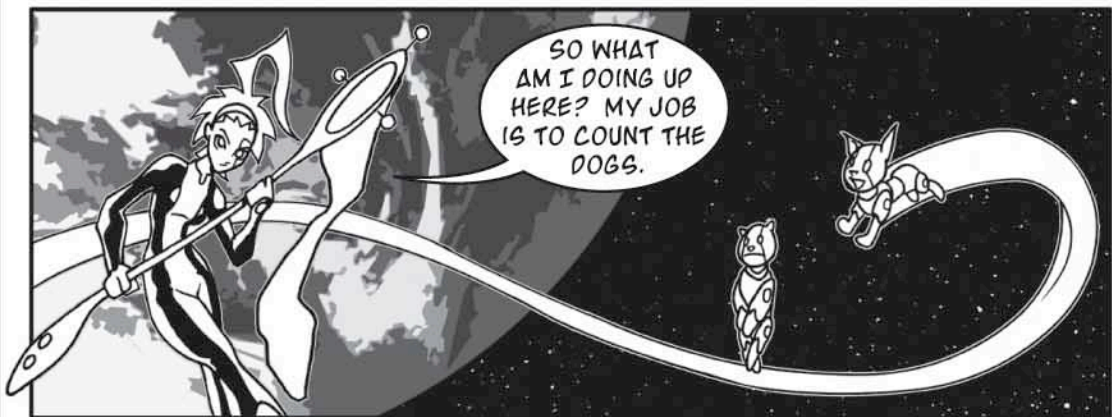

SO WHAT AM I DOING UP HERE? MY JOB IS TO COUNT THE DOGS.



THAT'S RIGHT. COUNT DOGS.



THE SCIENTISTS DOWN ON EARTH WANT TO KEEP TRACK OF HOW MANY DOGS THERE ARE UP HERE.



SO I CATCH THE DOGS WITH MY NET...



...COUNT THEM ALL, AND FIGURE OUT WHETHER THEY'RE ENERGIZED OR NOT.



THEN I SEND ALL THAT INFORMATION DOWN TO EARTH. HI THERE, ROBERTO!!



HI CINDI. HOW ARE THE DOGS DOING UP THERE TODAY?



OH, THE USUAL. THEY'RE JUMPING ALL OVER THE PLACE.



WELL, IT LOOKS LIKE YOU'LL GET SOME MORE EXCITEMENT.

THE FORECASTERS ARE PREDICTING A BIG PACK OF DOGS JUST AFTER YOU GO THROUGH SUNSET.



ROGER THAT! WE SHOULD BE ORBITING AROUND TO THE NIGHTSIDE IN JUST A FEW MINUTES. GOTTA GET READY! BYE, ROBERTO!



YOU'RE PROBABLY WONDERING WHY I HAVE TO HAVE TWO NETS HERE.

I HAVE TO USE ONE KIND FOR THE JUMPY DOGS AND A DIFFERENT KIND FOR THE SLEEPY DOGS. WATCH THIS!



HERE  
TAKS! HERE  
BOY!



YOU SEE? MY NEUTRAL NET  
IS NO GOOD FOR CATCHING AN  
ENERGETIC SPACEDOG. AND,  
THE ENERGETIC NET WON'T  
WORK ON A NEUTRAL  
SPACEDOG.







SO YOU'VE GOT TO USE THE RIGHT NET FOR THE RIGHT DOG!

NOW WE'RE COMING AROUND TO THE NIGHT SIDE OF THE EARTH, JUST AFTER SUNSET,

AND THAT'S WHERE WE FIND THE INTERESTING GROUPS OF SPACE DOGS.

THANKS FOR THE HELP, GUYS.

THERE'S THE PACK! LET'S GO!

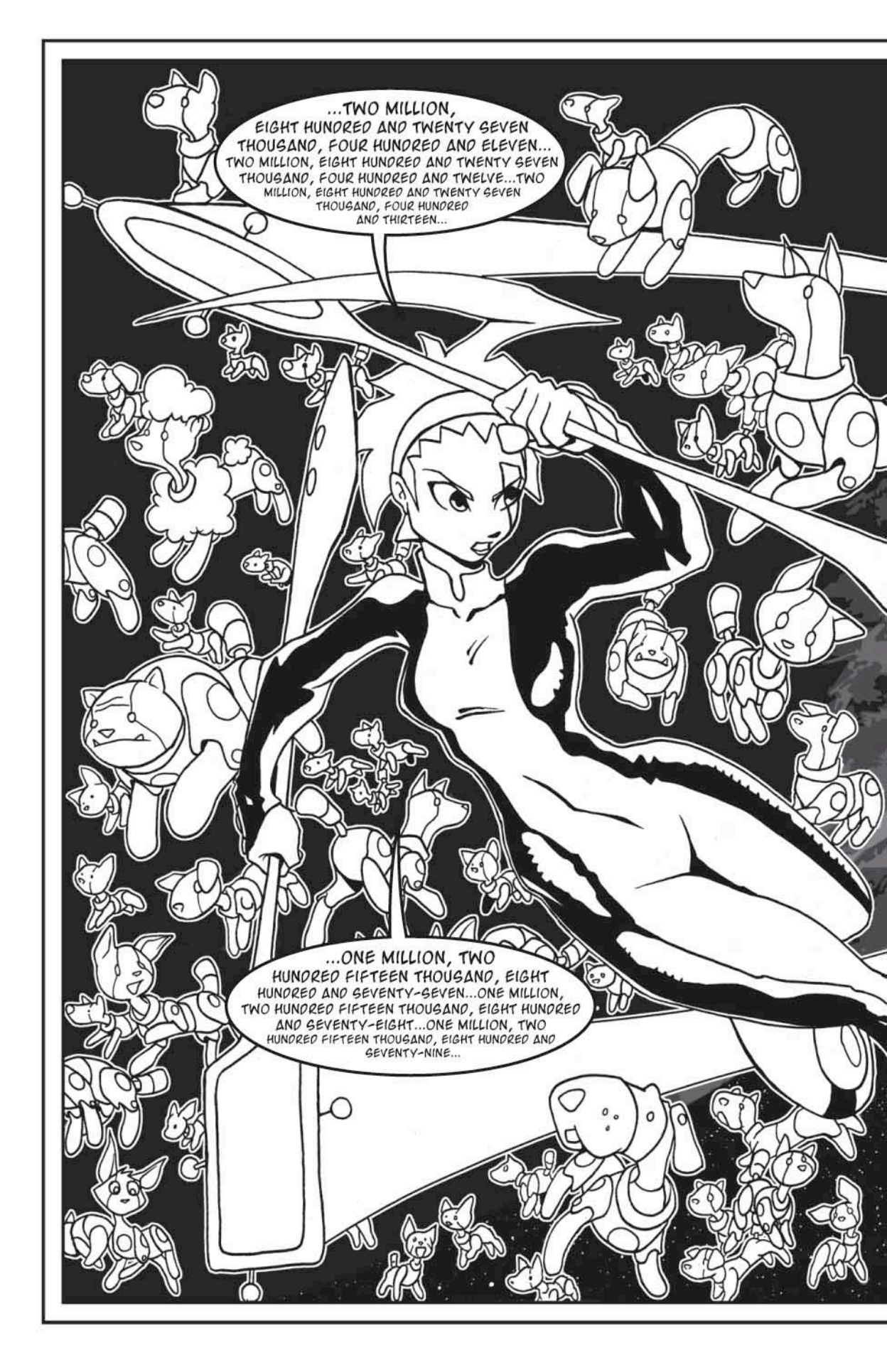

...TWO MILLION,  
EIGHT HUNDRED AND TWENTY SEVEN  
THOUSAND, FOUR HUNDRED AND ELEVEN...  
TWO MILLION, EIGHT HUNDRED AND TWENTY SEVEN  
THOUSAND, FOUR HUNDRED AND TWELVE...TWO  
MILLION, EIGHT HUNDRED AND TWENTY SEVEN  
THOUSAND, FOUR HUNDRED  
AND THIRTEEN...

...ONE MILLION, TWO  
HUNDRED FIFTEEN THOUSAND, EIGHT  
HUNDRED AND SEVENTY-SEVEN...ONE MILLION,  
TWO HUNDRED FIFTEEN THOUSAND, EIGHT HUNDRED  
AND SEVENTY-EIGHT...ONE MILLION, TWO  
HUNDRED FIFTEEN THOUSAND, EIGHT HUNDRED AND  
SEVENTY-NINE...

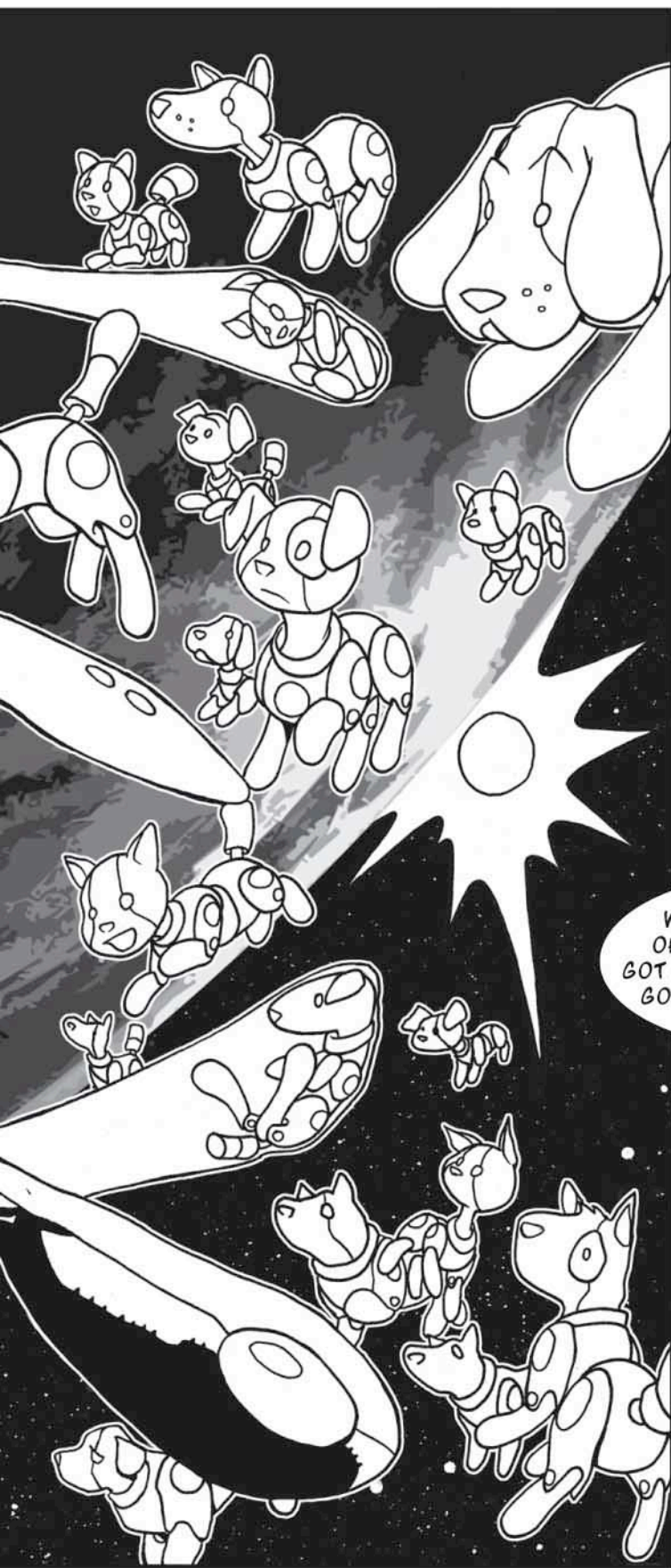

BUT THAT WAS A GREAT GROUP OF DOGS THERE, AND I GOT A LOT OF DATA THEY'RE GOING TO WANT BACK ON EARTH.



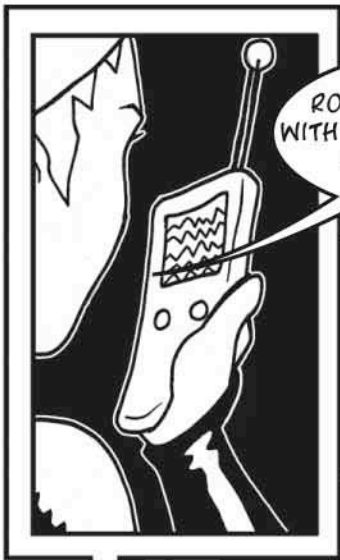

HOLA ROBERTO! I FINISHED WITH THAT PACK OF DOGS. I'M SENDING THE DATA NOW!

THANKS CINDI! WE GOT IT ALL NOW.



OKAY, ROBERTO! TALK TO YOU LATER!



WELL NOW THAT I'VE SHOWN YOU WHAT MY LIFE IS LIKE, LET ME SHOW YOU WHAT THE REAL CINDI IS LIKE AND WHAT IT DOES.



THIS IS THE C/NOFS (SAY "SEE-NOFS") SATELLITE IN SPACE. IT'S A SCIENTIFIC SATELLITE RUN BY THE US AIR FORCE AND NASA.

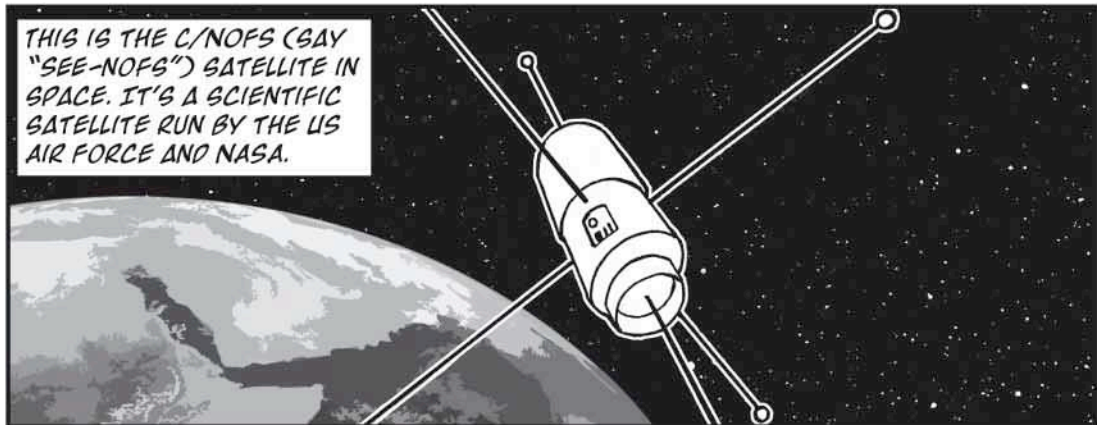

THE US AIR FORCE PUT IT INTO ORBIT AROUND THE EQUATOR AT ABOUT 550 KILOMETERS (OR 350 MILES) UP.

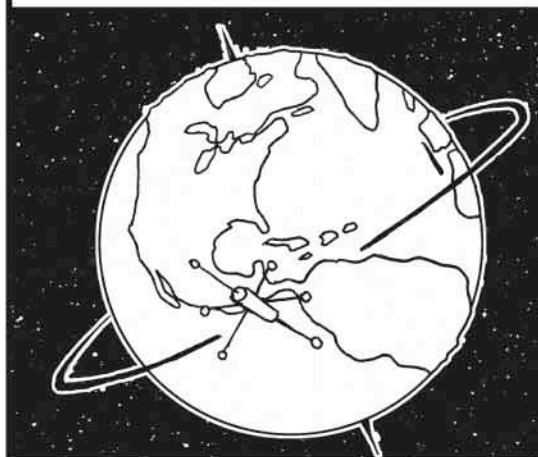

NOTE: PICTURE NOT TO SCALE. C/NOFS SHOULD BE MUCH CLOSER TO THE EARTH.

MOST FOLKS THINK THAT SPACE UP HERE IS EMPTY-- A COMPLETE VACUUM.



BUT INSIDE THIS ONE CENTIMETER CUBE UP HERE THERE ARE STILL ABOUT TO MILLION ATOMS AND MOLECULES OF AIR!



NOW THAT MAY SEEM LIKE A LOT, BUT DOWN ON EARTH WHERE YOU ARE, THAT SAME CUBE WOULD HAVE ABOUT TO MILLION MILLION MILLION ATOMS AND MOLECULES!



C/NOFS IS IN ORBIT IN THE PART OF THE ATMOSPHERE CALLED THE IONOSPHERE. IT'S CALLED THAT BECAUSE MANY OF THE AIR PARTICLES THERE ARE IONS.

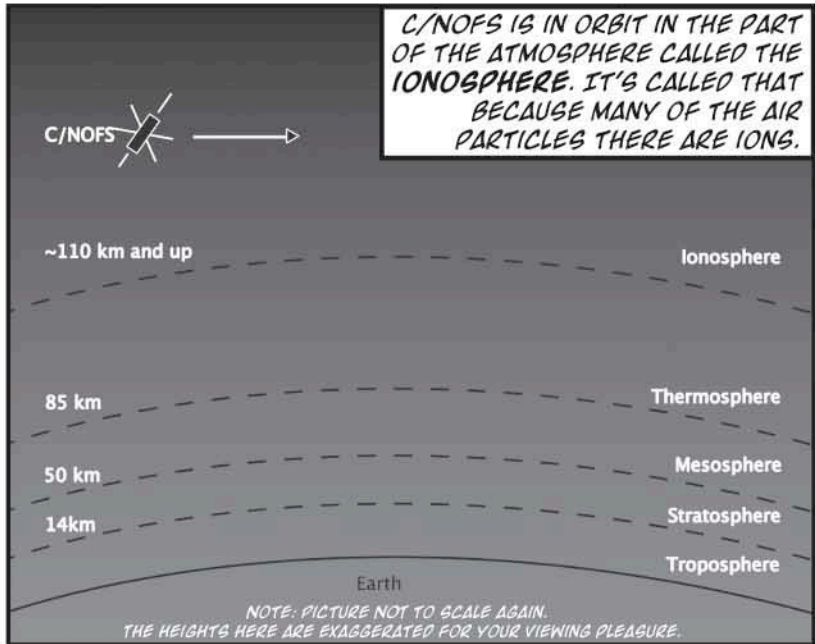

NOTE: PICTURE NOT TO SCALE AGAIN. THE HEIGHTS HERE ARE EXAGGERATED FOR YOUR VIEWING PLEASURE.

HERE'S A TYPICAL OXYGEN ATOM YOU WOULD FIND IN THE UPPER ATMOSPHERE. IT HAS AN EQUAL NUMBER OF POSITIVE PROTONS IN ITS CENTER AS IT HAS NEGATIVE ELECTRONS GOING AROUND IT. SO IT'S NEUTRAL, IT HAS NO NET CHARGE.

THE "OXYGEN" YOU BREATHE DOWN THERE IS REALLY A MOLECULE OF TWO OXYGEN ATOMS. WE'RE JUST SHOWING ONE OXYGEN ATOM HERE BECAUSE THAT'S THE WAY IT IS IN THE IONOSPHERE ...AND BECAUSE IT'S A LOT EASIER TO DRAW JUST ONE.

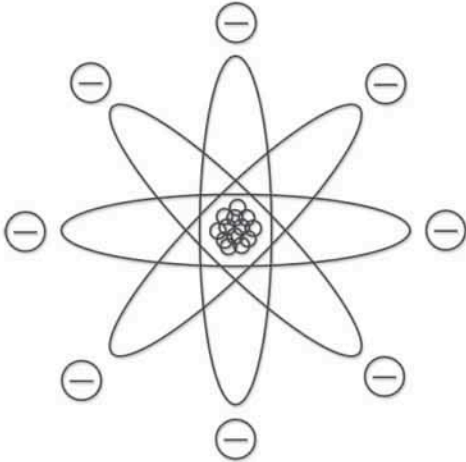

8 protons (+) + 8 electrons (-)  
Net Charge = 0

BUT SOMETIMES WHEN THE ATOM ABSORBS A PHOTON OF LIGHT, THE EXTRA ENERGY CAUSES ONE OF ITS ELECTRONS TO GET KICKED OFF. JUST LIKE ONE OF THE SPACEBOBS LOSING A TAIL WHEN THEY EAT AN ENERGY BISCUIT.

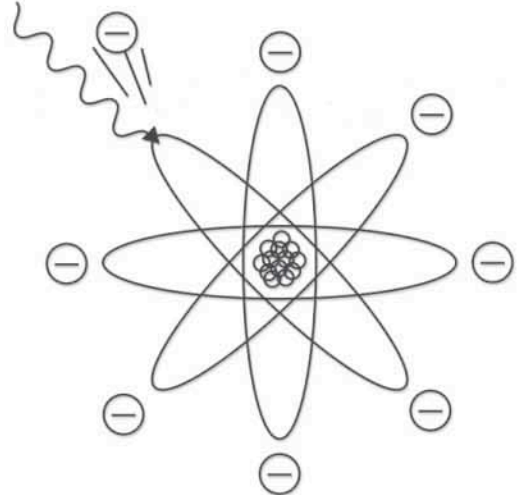

Net Charge = ?

NOW THE ATOM HAS ONE MORE POSITIVE CHARGE THAN NEGATIVE CHARGE, SO ITS NET ELECTRICAL CHARGE IS +1.

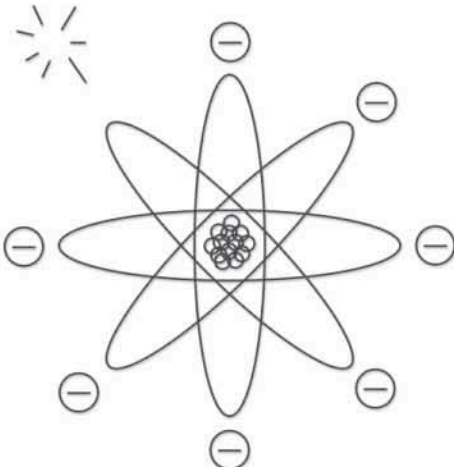

8 protons (+) + 7 electrons (-)  
Net Charge = +1

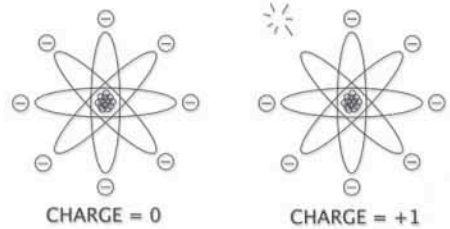

NEUTRAL

ION

WE CALL AN ATOM OR MOLECULE WITH NO NET CHARGE A "NEUTRAL"...

AND AN ATOM OR MOLECULE WITH A CHARGE AN "ION."





HERE IN THE IONOSPHERE WE HAVE A MIXTURE OF NEUTRALS AND IONS. IT'S SORT OF LIKE THE NEUTRAL AND ENERGETIC SPACE DOGS I HAVE UP HERE.

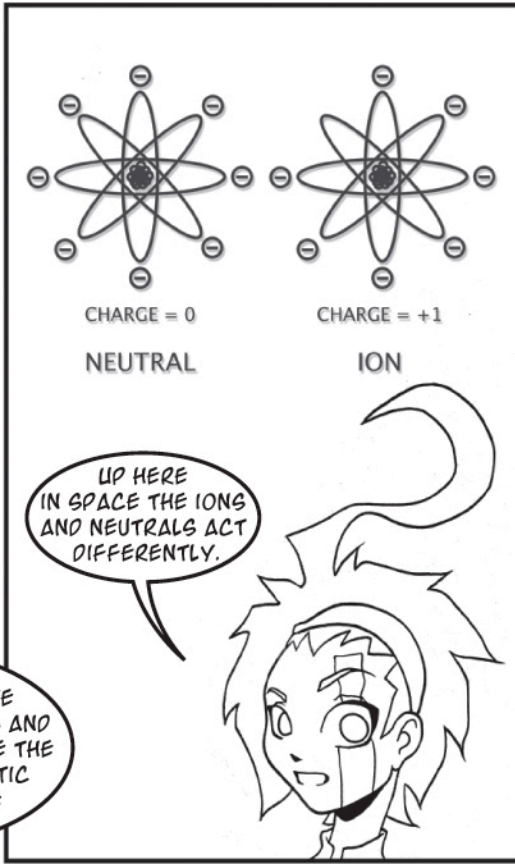

UP HERE IN SPACE THE IONS AND NEUTRALS ACT DIFFERENTLY.

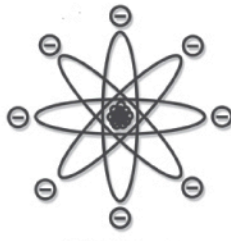

CHARGE = 0

NEUTRAL

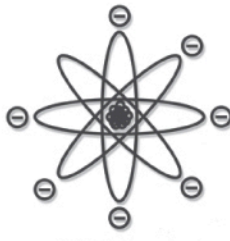

CHARGE = +1

ION

A NEUTRAL JUST MOVES UNDER THE COMBINED FORCES OF GRAVITY AND PRESSURE.

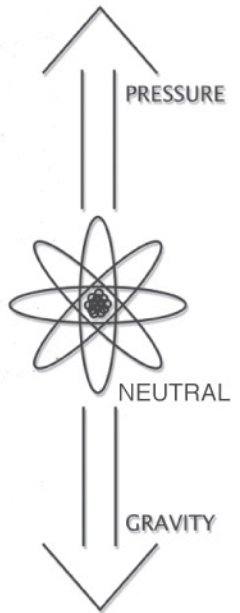

PRESSURE

NEUTRAL

GRAVITY

BUT SINCE AN ION IS ELECTRICALLY CHARGED, IT ALSO FEELS THE FORCE OF THE ELECTRIC FIELDS AND MAGNETIC FIELDS UP HERE. SO IT MOVES AROUND UNDER THE COMBINED EFFECT OF ALL FOUR FORCES, AND GENERALLY TRIES TO MOVE IN A DIFFERENT DIRECTION THAN THE NEUTRALS ARE MOVING.

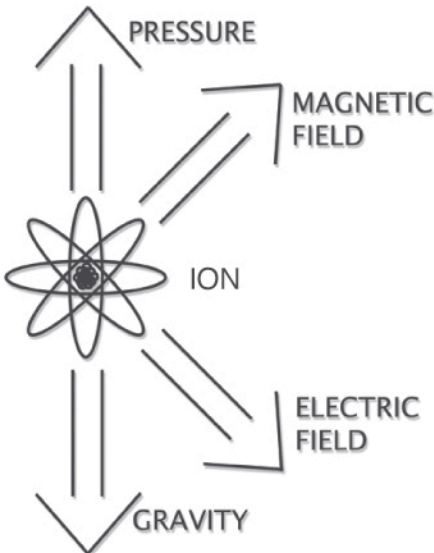

PRESSURE

MAGNETIC FIELD

ION

ELECTRIC FIELD

GRAVITY

IF WE HAD JUST NEUTRALS OR JUST IONS...

...THEY WOULD ALL MOVE TOGETHER IN THE SAME DIRECTION.

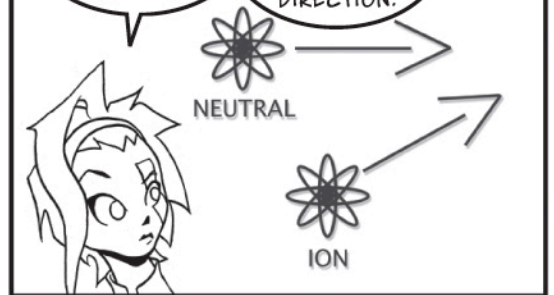

NEUTRAL

ION

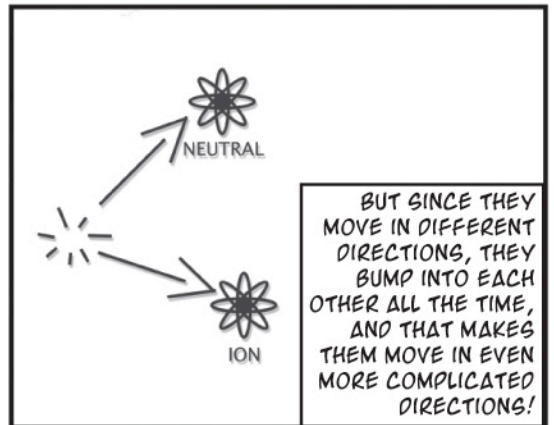

BUT SINCE THEY MOVE IN DIFFERENT DIRECTIONS, THEY BUMP INTO EACH OTHER ALL THE TIME, AND THAT MAKES THEM MOVE IN EVEN MORE COMPLICATED DIRECTIONS!

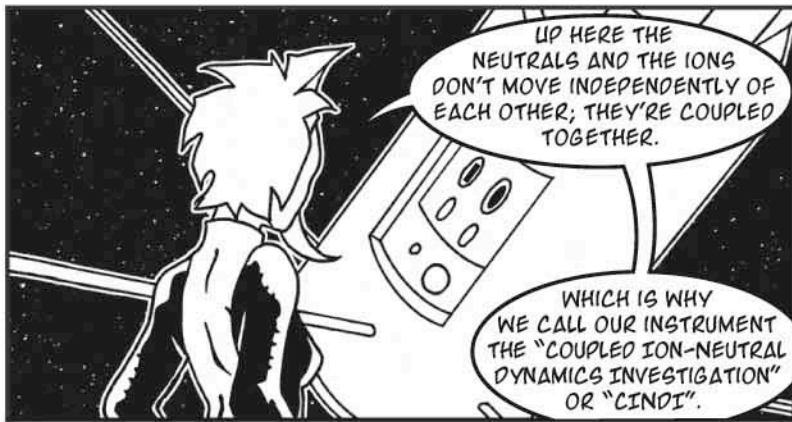

UP HERE THE NEUTRALS AND THE IONS DON'T MOVE INDEPENDENTLY OF EACH OTHER; THEY'RE COUPLED TOGETHER.

WHICH IS WHY WE CALL OUR INSTRUMENT THE "COUPLED ION-NEUTRAL DYNAMICS INVESTIGATION" OR "CINDI".



...AND I USED TO THINK THEY NAMED IT AFTER ME...



JUST LIKE I COUNT THE NEUTRAL AND ENERGETIC SPACEDOGS UP HERE, CINDI MEASURES THE IONS AND NEUTRALS HERE IN ORBIT.

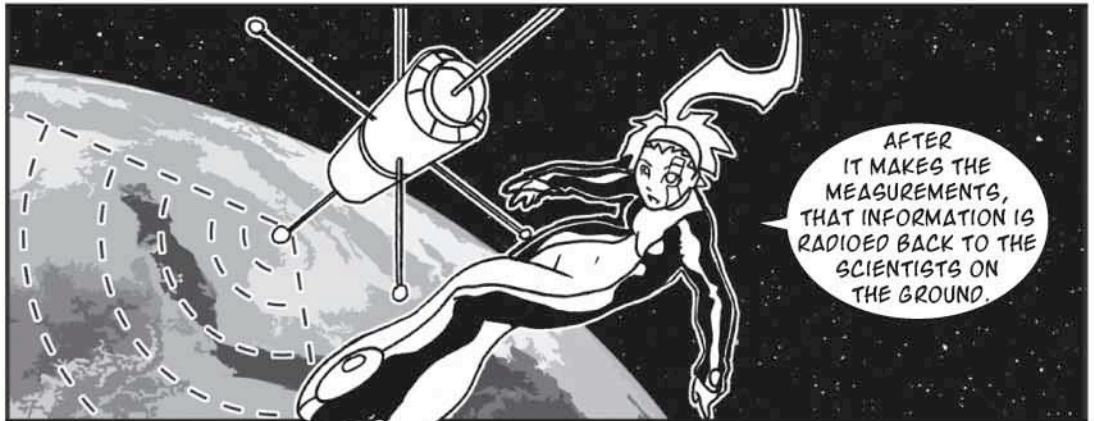

AFTER IT MAKES THE MEASUREMENTS, THAT INFORMATION IS RADIOED BACK TO THE SCIENTISTS ON THE GROUND.

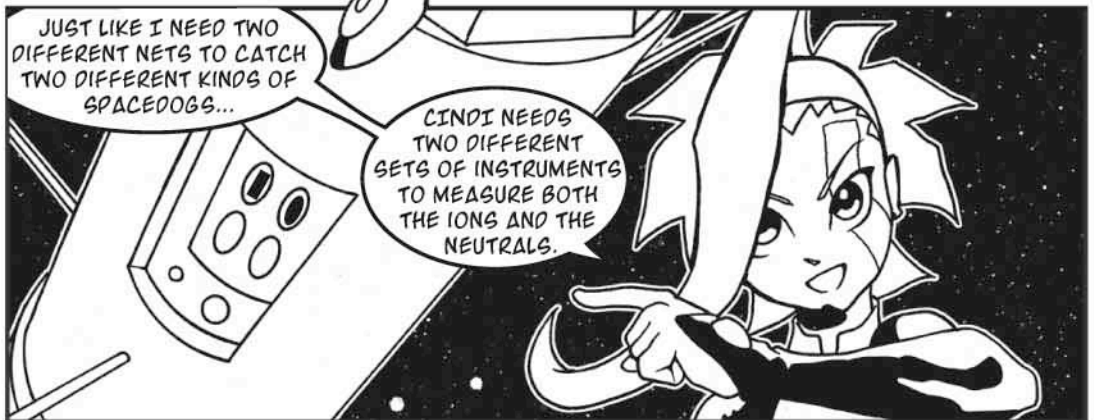

JUST LIKE I NEED TWO DIFFERENT NETS TO CATCH TWO DIFFERENT KINDS OF SPACEDOGS...

CINDI NEEDS TWO DIFFERENT SETS OF INSTRUMENTS TO MEASURE BOTH THE IONS AND THE NEUTRALS.



THIS IS THE ION VELOCITY METER OR IVM. IT HAS TWO PARTS AND IT DETECTS ONLY THE IONS THAT GET INSIDE AND IGNORES THE NEUTRALS.

### ARRIVAL ANGLE MEASUREMENT

Ion Drift Meter

Cross-Track Wind Sensor

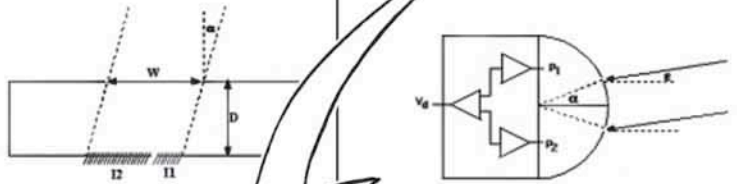

$$\frac{I_1}{I_2} = \frac{W/2 - D \tan \alpha}{W/2 + D \tan \alpha}$$

$$C \ln \left( \frac{P_1}{P_2} \right) = G_d C \ln \left( \frac{\cos(\alpha - \epsilon)}{\cos(\alpha + \epsilon)} \right)$$

Arrival angle proportional to Current Ratio

Arrival angle proportional to Pressure Ratio

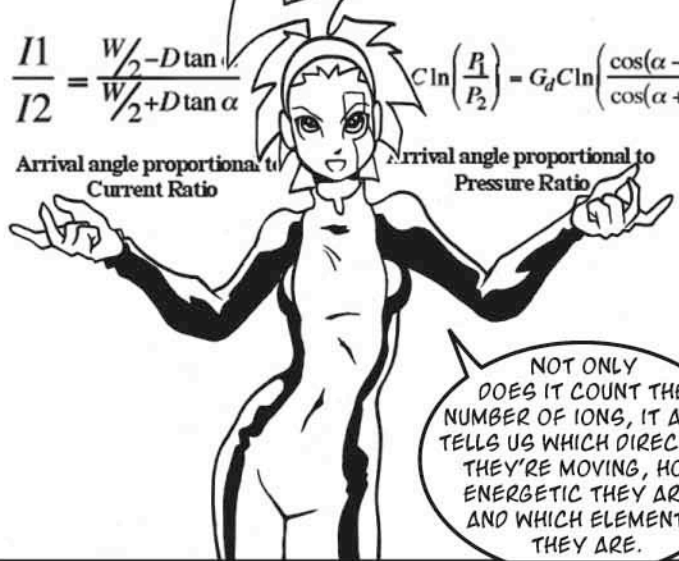

NOT ONLY DOES IT COUNT THE NUMBER OF IONS, IT ALSO TELLS US WHICH DIRECTION THEY'RE MOVING, HOW ENERGETIC THEY ARE, AND WHICH ELEMENTS THEY ARE.

THIS IS THE NEUTRAL WIND METER OR NWM.

IT ALSO HAS TWO PARTS, AND IT HAS AN ELECTRIC FIELD IN FRONT OF IT TO KEEP THE IONS OUT SO IT ONLY MEASURES THE NEUTRALS.

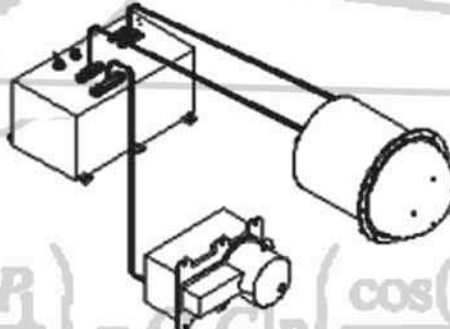

JUST LIKE THE IVM, THE NWM COUNTS THE NUMBER OF NEUTRALS AND TELLS US IN WHAT DIRECTION THEY'RE MOVING.

SO WHY WOULD ANYONE CARE ABOUT MEASURING THESE IONS AND NEUTRALS OUT IN SPACE?





WELL, THESE DIFFERENT FORCES AFFECTING THE IONS AND NEUTRALS UP HERE CREATE BIG STRUCTURES IN THE IONOSPHERE THAT ARE ALWAYS CHANGING.



ITS JUST LIKE THE WEATHER THAT'S ALWAYS CHANGING DOWN THERE WHERE YOU ARE. IN FACT, THAT'S WHY WE CALL THIS "SPACE WEATHER."

FOR EXAMPLE, NEAR THE EQUATOR JUST AFTER SUNSET YOU CAN HAVE REGIONS IN THE LOWER IONOSPHERE WHERE THE DENSITY OF IONS IS LOW, WHILE THERE ARE REGIONS ABOVE THAT WHERE THE DENSITIES ARE HIGHER.

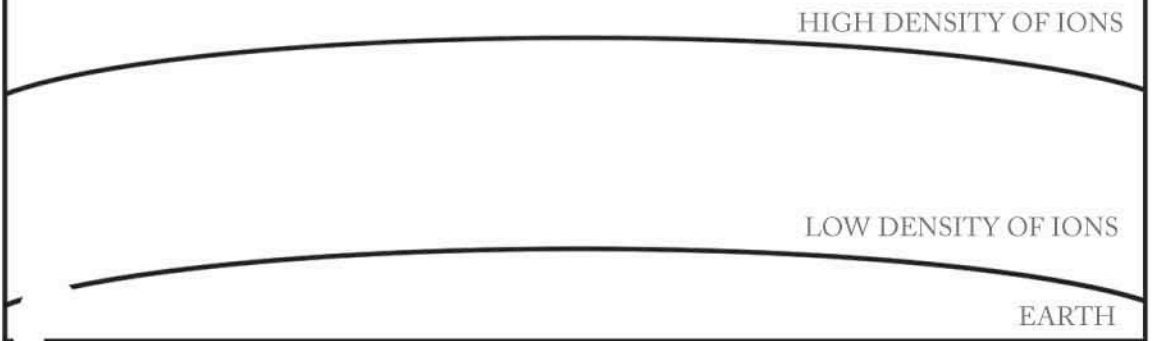

SOMETIMES NOTHING HAPPENS. BUT AT OTHER TIMES BUBBLES OF LOW DENSITY IONS FORM AND MOVE UPWARD.

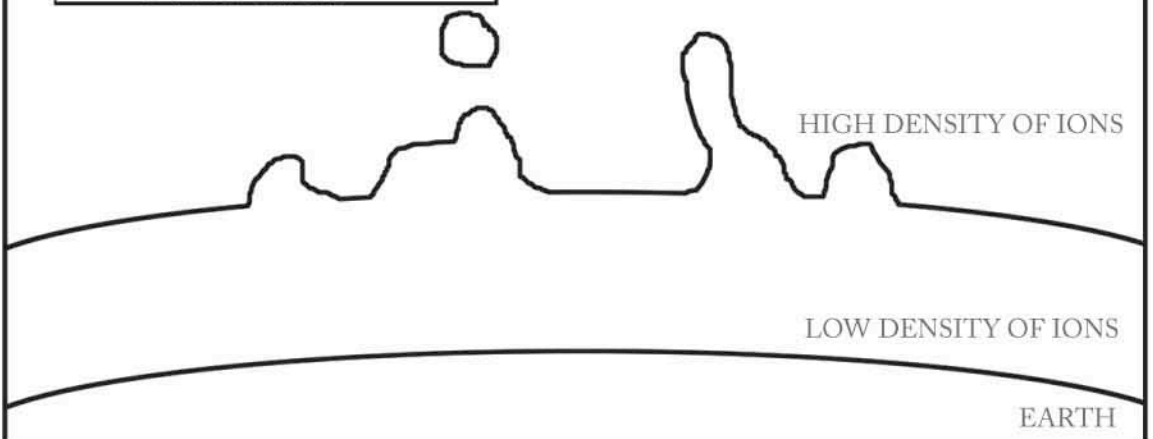

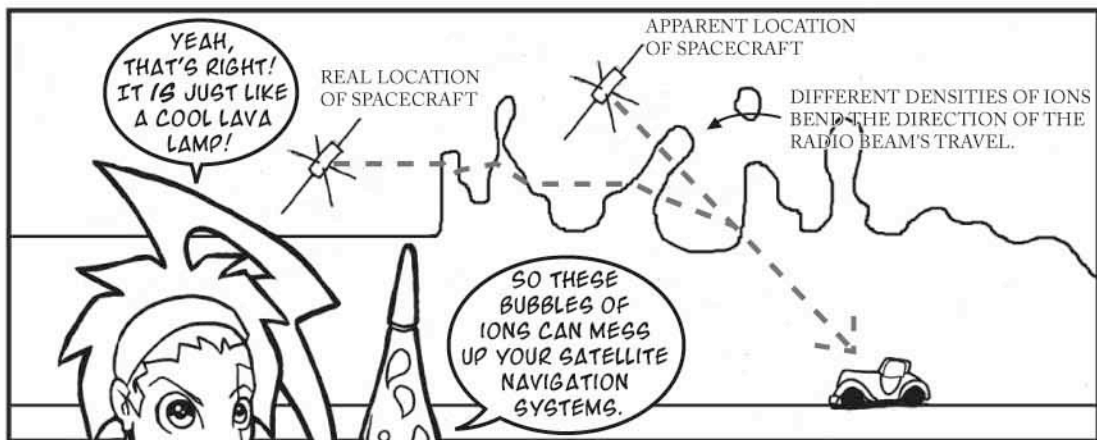

BUT THIS DOESN'T HAPPEN ALL OF THE TIME, JUST SOME OF THE TIME. LIKE I SAID, IT'S JUST LIKE WEATHER.



DAY BEFORE YESTERDAY



YESTERDAY

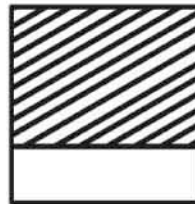

TODAY

IF WE COULD FORECAST THE SPACE WEATHER JUST LIKE WE FORECAST THE WEATHER DOWN ON THE GROUND, THEN WE'D KNOW AHEAD OF TIME WHEN THESE BUBBLES WERE GOING TO INTERFERE WITH OUR SATELLITES.



Strong Solar Winds  
Tomorrow



Southern Aurora  
Tonight

80% Chance  
Of Bubbles

Heightened  
Kp Index

THAT'S WHY WE CALL OUR SATELLITE THE "COMMUNICATIONS/ NAVIGATION OUTAGE FORECAST SATELLITE" OR "C/NOFS".



NO, I DON'T THINK THAT NAME IS ANYWHERE NEAR AS NICE AS CINDI EITHER...



AS THE SATELLITE FLIES THROUGH THE BUBBLES WE MEASURE THEIR SIZE, STRUCTURE, DENSITIES, ENERGIES, AND COMPOSITION.

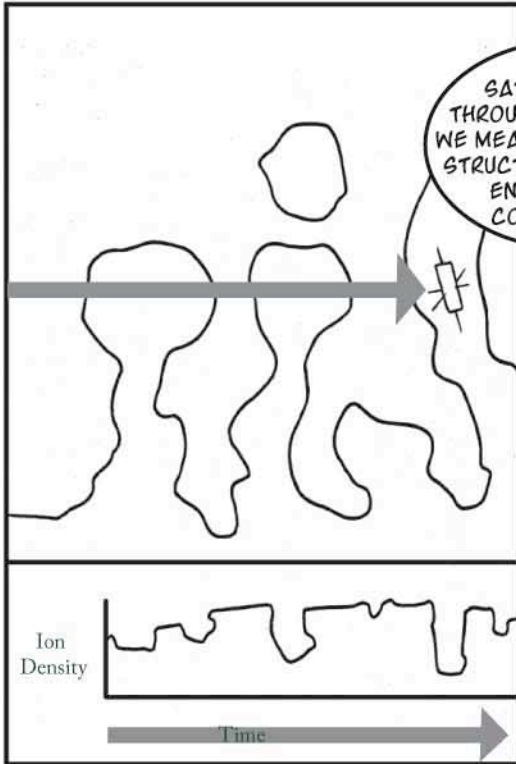

YOU SEE,  
BY MEASURING  
THESE CONDITIONS IN THE  
IONOSPHERE BOTH BEFORE  
THE BUBBLES OCCUR AND THEN  
AFTER THEY FORM, WE  
CAN FIGURE OUT HOW TO  
**PREDICT** WHEN AND  
WHERE THEY WILL  
HAPPEN.



IT'S JUST  
LIKE WEATHER  
WARNINGS ON THE  
GROUND. IF WE CAN  
FORECAST WHEN AND  
WHERE THESE BUBBLES  
WILL HAPPEN, THEN WE  
CAN TAKE ACTIONS TO  
WORK AROUND THE  
PROBLEMS THEY  
CAUSE FOR OUR  
SATELLITES  
AND...



HEY,  
CINDI!!!





WE JUST GOT ANOTHER REPORT OF A PACK OF SPACE DOGS NEAR YOU. CAN YOU GO CHECK IT OUT?



WELL, I'VE  
GOT TO GO CHECK  
OUT THOSE SPACE  
DOGS. COME BACK  
SOON FOR MORE  
ADVENTURES!

AND  
KEEP LEARNING!  
BYE!



WOULD YOU LIKE TO KNOW MORE ABOUT THE CINDI INSTRUMENT, THE C/NOFS SATELLITE, THE IONOSPHERE, AND EVEN DOWNLOAD A COPY OF MY ADVENTURES HERE TO PRINT OUT ON YOUR OWN? THEN COME TO OUR REALLY COOL WEBSITE:

[HTTP://CINDISPACE.UTDALLAS.EDU/EDUCATION/](http://cindispace.utdallas.edu/education/)



WE HAVE MORE INFORMATION ABOUT THE CINDI MISSION THERE, CLASSROOM PROJECTS, CURRICULUM STUFF FOR TEACHERS, AND EVEN REAL DATA FROM CINDI, AND PROJECTS YOU CAN DO TO ANALYZE THE DATA! COME SEE THE LATEST CINDI NEWS THERE!

AND HERE ARE ALL THE FOLKS WHO CREATED ALL THIS:  
STORY BY: **DR. MARY URQUHART AND DR. MARC HAIRSTON**

SCRIPT AND STORYBOARDING BY: **DR. MARC HAIRSTON**  
AMAZING CHARACTER DESIGNS, STUPENDOUS ARTWORK,  
STUNNING LAYOUTS, AND IMPECCABLE LETTERING BY:  
**ERIK LEVOLD**

COLORING BY: **DIANA MARSH AND JESSICA FUCHS**  
ORIGINAL CONCEPT OF CINDI CHARACTER CREATED BY:

**DR. MARY URQUHART, DR. MARC HAIRSTON,  
JIM RICHARDSON, AND CHARLENE OLSEN.**

CINDI COMIC PROJECT DIRECTOR: **DR. MARC HAIRSTON**

SPECIAL THANKS TO **DR. FRENCHY LUNNING AT  
THE MINNEAPOLIS COLLEGE OF ART AND DESIGN**

NO PROTONS OR ELECTRONS WERE HARMED IN THE MAKING OF  
THIS BOOK.

THIS BOOK WAS PRODUCED WITH FUNDS FROM NASA UNDER THE EDUCATION AND PUBLIC OUTREACH PROGRAM OF THE CINDI SMALL EXPLORER MISSION (NASS-01068). COPIES OF THIS BOOK MAY BE FREELY COPIED AND REDISTRIBUTED SO LONG AS ALL THESE CREDITS REMAIN ATTACHED. FOR ANY FURTHER QUESTIONS, PLEASE CONTACT US BY EMAIL AT [HAIRSTON@UTDALLAS.EDU](mailto:HAIRSTON@UTDALLAS.EDU) AND [URQUHART@UTDALLAS.EDU](mailto:URQUHART@UTDALLAS.EDU).  
© 2005 THE UNIVERSITY OF TEXAS AT DALLAS.